

CAPE COD SYSTEMS CORPORATION

TEL. 1-888-227-8555

www.capecodsystems.com



ACCURATE

LOCK & HARDWARE

AMERICAN CRAFTED SINCE 1972

DOUBLE LIP STRIKES

RESCUE HARDWARE

DOUBLE LIP STRIKES

ALLOW DOORS TO OPEN IN BOTH DIRECTIONS

Available in various jamb widths for center or offset doors.

Traditional Double Lip Strikes

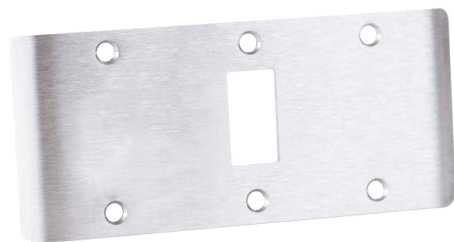

ADL-C
Center

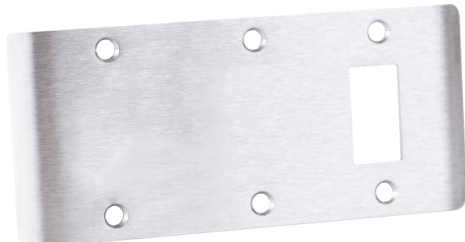

ADL-O
Offset

Double Lip Strikes with Emergency Stop

Featuring a heavy duty stop to absorb impact of slamming doors.

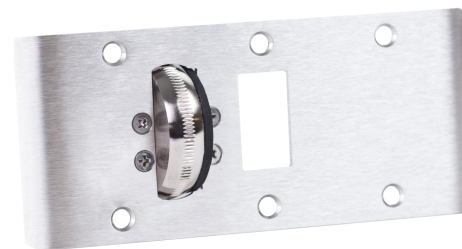

ADL-CE-HD
Center

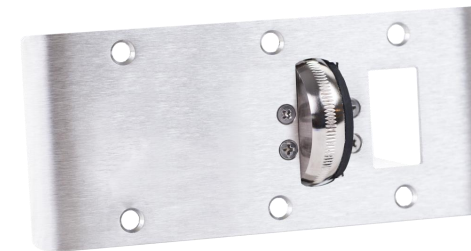

ADL-OE-HD
Offset

Double Lip Strikes with Keyed Emergency Stop

Featuring a keyed heavy duty stop designed to prevent unauthorized outswing of door.

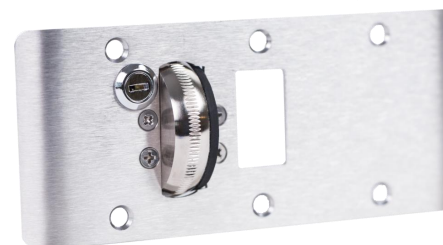

ADL-CEK-HD
Center

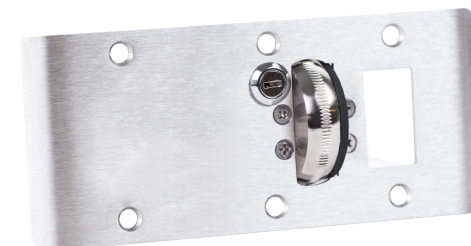

ADL-OEK-HD
Offset

ADL-C EMERGENCY STOP

Part Number	Jamb Width "A"	Screw Center to Center "B"
ADL-C-1	4 ¾"	1 3/8"
ADL-C-2	5 5/8"	1 ¾"
ADL-C-3	5 ¾"	1 7/8"
ADL-C-4	5 7/8"	1 15/16"
ADL-C-5	6 ¼"	2 1/8"
ADL-C-6	6 ¾"	2 3/8"
ADL-C-7	7 1/8"	2 ½"
ADL-C-8	7 ¾"	2 7/8"
ADL-C-9	8 ¼"	3 1/8"
ADL-C-10	8 ¾"	3 3/8"
ADL-C-CUSTOM		Fax or email your specs for quotation

All part numbers shown are for 2 ¾" tall strikes, set up for use with cylindrical locks on 1 ¾" thick doors. All standard sizes are supplied with #8-32 x ¾" combo (machine/wood) screws.

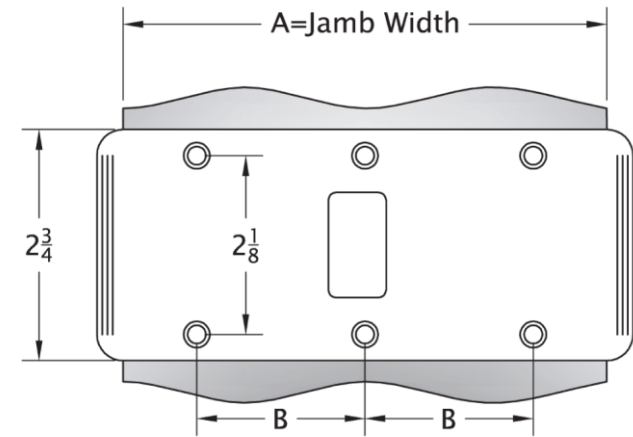
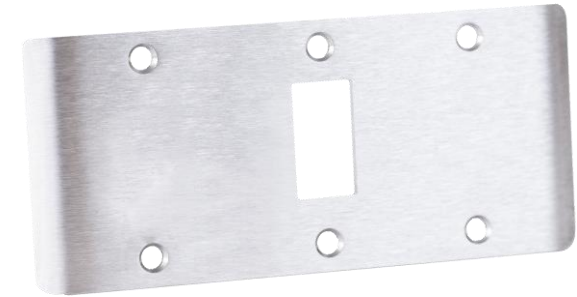

ADL-C
Accurate Double Lip Strike
For Center Hung Doors

Please specify:
Quantity x Part Number x Finish
(i.e. 30 x ADL-C-3 X US32D)

ADL-O EMERGENCY STOP

Part Number	Jamb Width "A"	Screw Center to Center "B"
ADL-O-1	4 3/4"	1 3/8"
ADL-O-2	5 5/8"	1 3/4"
ADL-O-3	5 3/4"	1 7/8"
ADL-O-4	5 7/8"	1 15/16"
ADL-O-5	6 1/4"	2 1/8"
ADL-O-6	6 3/4"	2 3/8"
ADL-O-7	7 1/8"	2 1/2"
ADLO-8	7 3/4"	2 7/8"
ADL-O-9	8 1/4"	3 1/8"
ADL-O-10	8 3/4"	3 3/8"
ADL-O-CUSTOM		Fax or email your specs for quotation

All part numbers shown are for 2 3/4" tall strikes, set up for use with cylindrical locks on 1 3/4" thick doors. All standard sizes are supplied with #8-32 x 3/4" combo (machine/wood) screws.

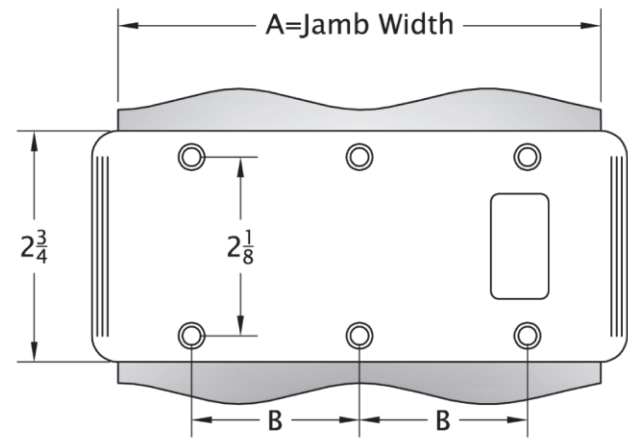
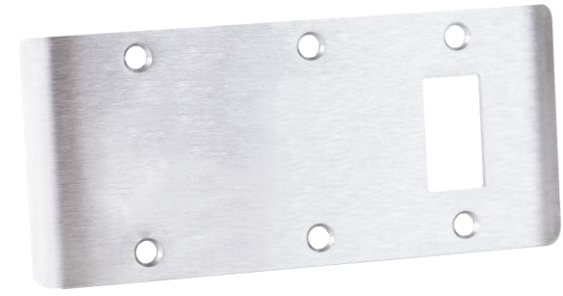

ADL-O
Accurate Double Lip Strike
For Offset (edge) Hung Doors

Please specify:
Quantity x Part Number x Finish
(i.e. 30 x ADL-C-3 X US32D)

ADL-CE-HD EMERGENCY STOP

Part Number	Jamb Width "A"	Screw Center to Center "B"
ADL-CE-HD-1	4 ¾"	1 3/8"
ADL-CE-HD-2	5 5/8"	1 ¾"
ADL-CE-HD-3	5 ¾"	1 7/8"
ADL-CE-HD-4	5 7/8"	1 15/16"
ADL-CE-HD-5	6 ¼"	2 1/8"
ADL-CE-HD-6	6 ¾"	2 3/8"
ADL-CE-HD-7	7 1/8"	2 ½"
ADL-CE-HD-8	7 ¾"	2 7/8"
ADL-CE-HD-9	8 ¼"	3 1/8"
ADL-CE-HD-10	8 ¾"	3 3/8"
ADL-CE-HD-CUSTOM		Fax or email your specs for quotation

All part numbers shown are for 2 ¾" tall strikes, set up for use with cylindrical locks on 1 ¾" thick doors.

All standard sizes are supplied with #8-32 x ¾" combo (machine/wood) screws.

Please specify:
Quantity x Part Number x Finish
(i.e. 30 x ADL-CE-HD-3 X US32D)

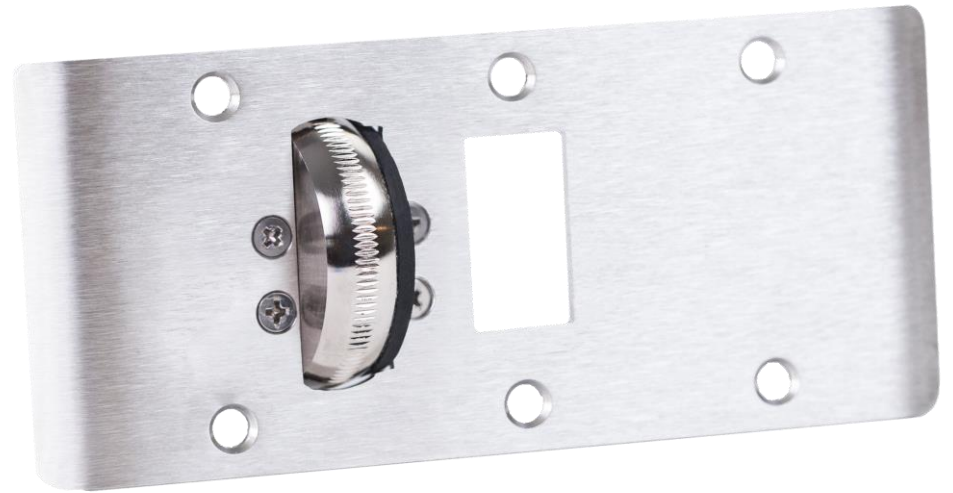

ADL-OE-HD EMERGENCY STOP

Part Number	Jamb Width "A"	Screw Center to Center "B"
ADL-OE-HD-1	4 ¾"	1 3/8"
ADL-OE-HD-2	5 5/8"	1 ¾"
ADL-OE-HD-3	5 ¾"	1 7/8"
ADL-OE-HD-4	5 7/8"	1 15/16"
ADL-OE-HD-5	6 ¼"	2 1/8"
ADL-OE-HD-6	6 ¾"	2 3/8"
ADL-OE-HD-7	7 1/8"	2 ½"
ADL-OE-HD-8	7 ¾"	2 7/8"
ADL-OE-HD-9	8 ¼"	3 1/8"
ADL-OE-HD-10	8 ¾"	3 3/8"
ADL-OE-HD-CUSTOM		Fax or email your specs for quotation

All part numbers shown are for 2 ¾" tall strikes, set up for use with cylindrical locks on 1 ¾" thick doors.

All standard sizes are supplied with #8-32 x ¾" combo (machine/wood) screws.

Please specify:
Quantity x Part Number x Finish
(i.e. 30 x ADL-OE-HD-3 X US32D)

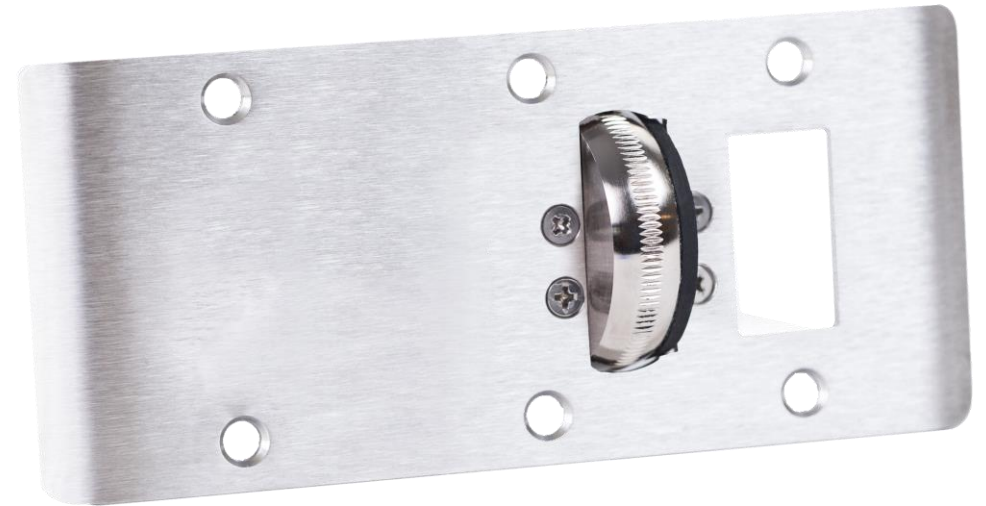

ADL-CEK-HD KEYED EMERGENCY STOP

- Key locks emergency stop into projected position
- Key unlocks emergency stop allowing stop to be retracted
- *Optional:* key locks emergency stop into projected position *and into retracted position (ADL-CEK-HDR)*

Part Number	Jamb Width "A"	Screw Center to Center "B"
ADL-CEK-HD-1	4 ³ / ₄ "	1 ³ / ₈ "
ADL-CEK-HD-2	5 ⁵ / ₈ "	1 ³ / ₄ "
ADL-CEK-HD-3	5 ³ / ₄ "	1 ⁷ / ₈ "
ADL-CEK-HD-4	5 ⁷ / ₈ "	1 ¹⁵ / ₁₆ "
ADL-CEK-HD-5	6 ¹ / ₄ "	2 ¹ / ₈ "
ADL-CEK-HD-6	6 ³ / ₄ "	2 ³ / ₈ "
ADL-CEK-HD-7	7 ¹ / ₈ "	2 ¹ / ₂ "
ADL-CEK-HD-8	7 ³ / ₄ "	2 ⁷ / ₈ "
ADL-CEK-HD-9	8 ¹ / ₄ "	3 ¹ / ₈ "
ADL-CEK-HD-10	8 ³ / ₄ "	3 ³ / ₈ "
ADL-CEK-HD-CUSTOM		Fax or email your specs for quotation

All part numbers shown are for 2 ³/₄" tall strikes, set up for use with cylindrical locks on 1 ³/₄" thick doors.

All standard sizes are supplied with #8-32 x ³/₄" combo (machine/wood) screws.

Please specify:

Quantity x Part Number x Finish
(i.e. 30 x ADL-CEK-HD-3 X US32D)

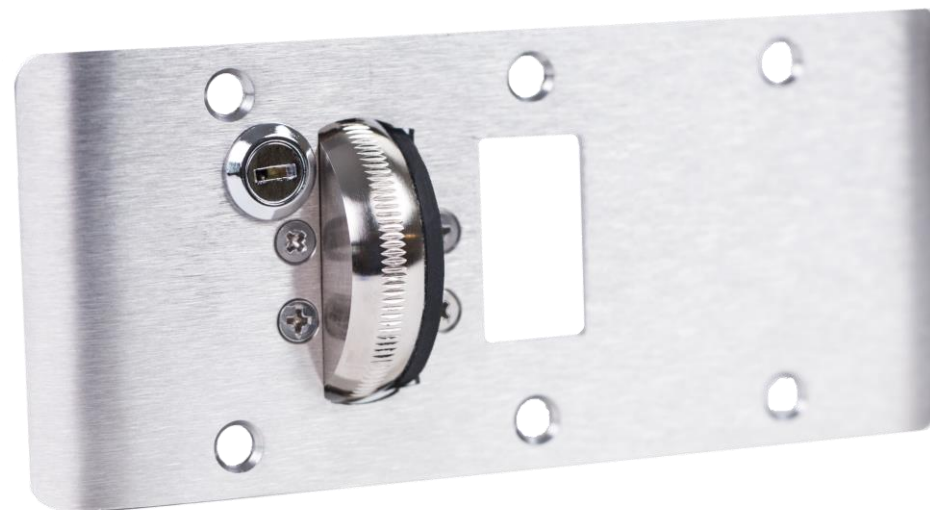

ADL-OEK-HD KEYED EMERGENCY STOP

- Key locks emergency stop into projected position
- Key unlocks emergency stop allowing stop to be retracted
- *Optional:* key locks emergency stop into projected position *and into retracted position (ADL-OEK-HDR)*

Part Number	Jamb Width "A"	Screw Center to Center "B"
ADL-OEK-HD-1	4 ¾"	1 3/8"
ADL-OEK-HD-2	5 5/8"	1 ¾"
ADL-OEK-HD-3	5 ¾"	1 7/8"
ADL-OEK-HD-4	5 7/8"	1 15/16"
ADL-OEK-HD-5	6 ¼"	2 1/8"
ADL-OEK-HD-6	6 ¾"	2 3/8"
ADL-OEK-HD-7	7 1/8"	2 ½"
ADL-OEK-HD-8	7 ¾"	2 7/8"
ADL-OEK-HD-9	8 ¼"	3 1/8"
ADL-OEK-HD-10	8 ¾"	3 3/8"
ADL-OEK-HD-CUSTOM		Fax or email your specs for quotation

All part numbers shown are for 2 ¾" tall strikes, set up for use with **cylindrical** locks on 1 ¾" thick doors.

All standard sizes are supplied with #8-32 x ¾" combo (machine/wood) screws.

Please specify:
Quantity x Part Number x Finish
(i.e. 30 x ADL-OEK-HD-3 X US32D)

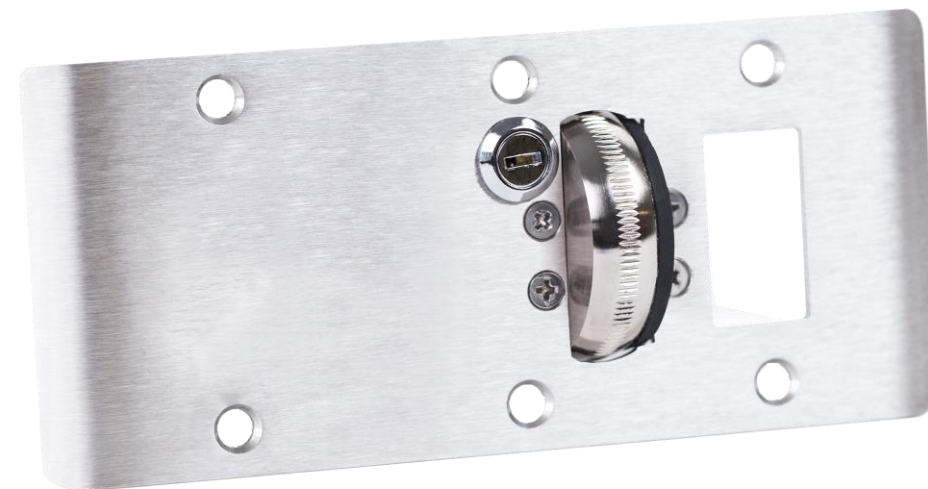

CAPE COD SYSTEMS CORPORATION

TEL. 1-888-227-8555

www.capecodsystems.com

ACCURATE LOCK & HARDWARE

MANUFACTURERS OF CUSTOM LOCKS

AND ARCHITECTURAL HARDWARE